

STRANA VN

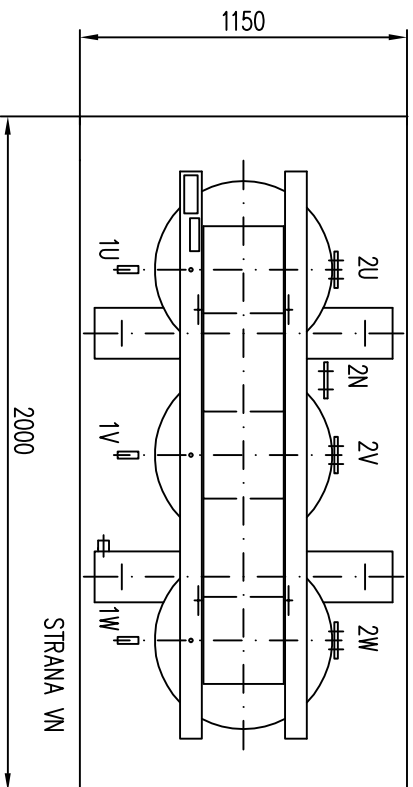

1 VN PŘÍPOJ. PRAPORCE

2 NN PŘÍPOJ. PRAPOREC

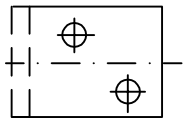
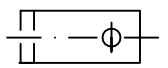

Typ	DITH 400/20	P _o [W]	1200
Výkon [kVA]	400	P _k [W]	4850
VN [kV]	22	UK [%]	6
NN [V]	400	KRYTÍ	IP 23
SKUP. ZAPOJENÍ	Dyn11	HMOTNOST [kg]	1950